

# US96-EN Pushbutton

The square shaped US96-EN braille pushbutton is designed to satisfy the demands of the EN81-70 standard, as well as meeting all the requirements of the visually impaired. The pushbutton is made up of four elements: switch body, illumination, pressel, and surround. This data sheet includes detailed information on each element and the options available for the US96-EN pushbutton.

The character or symbol, known as the legend, provides clear identification. The legend and the halo (light created between the pressel and the surround) can be illuminated in a wide variety of colours.

Image shows US96-EN pushbutton with Compact 3 switch body, chrome surround, and black anodised pressel.



## Switch body

The switch body is the functional part of the pushbutton. The US96-EN is available with Compact 3, Compact 3P and Compact 2 Micro switch bodies.

## Pressel

The pressel is the faceplate of the pushbutton. Standard US96-EN pressels are a black anodised plate moulded with opal polycarbonate. Green and yellow material finishes are available for exit floor and alarm buttons.

There is an extensive range of pressel legends to choose from. All legends are 15mm high and tactile, with standard English braille dots below.

## Illumination

Single, dual, bicolour and bicolour+ LED illumination options are available for the US96-EN. These illuminate both the legend and the halo. They are easily replaceable and available in blue, white, red, amber and green.

## Surround

The surround is the element of the pushbutton which sits in front of the pressel and clicks into the switch body. US96-EN pushbutton surrounds are available in a wide variety of material, depth and colour.

Standard material finishes include clear plastic, chrome, brass, satin chrome, black and green.

## Key features

- Standard black pressel finish moulded with opal polycarbonate.
- Extensive range of pressel legends to choose from with bespoke designs available on request.
- Legends are 15mm high and tactile with braille.
- Legend and halo illumination.
- Vandal resistant - meets EN81-71.
- Meets EN81-70 standard for accessible lifts.
- Similar style available in jumbo.

# Switch body | Compact 3 & Compact 3P

The switch body is the functional part of the pushbutton. Both the Compact 3 and 3P switch bodies offer the full range of illumination options as well as all possible contact configurations.

## Dimensions

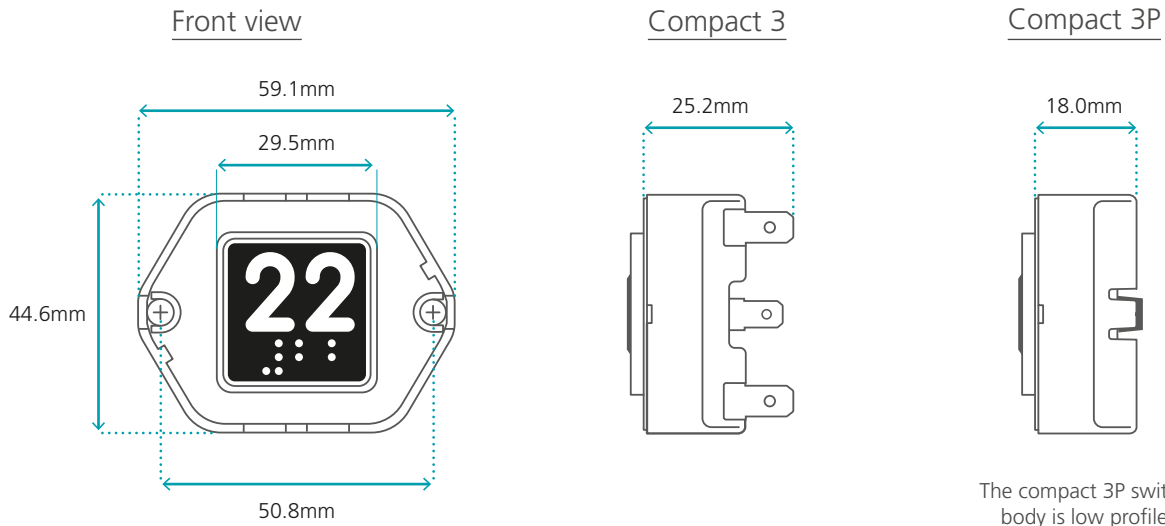

## Technical details

<b>Power (continuous)</b>	2.5 watts (maximum)
<b>Contact arrangements</b>	2 Normally Open contacts
	2 Normally Closed contacts
	1 Normally Open contact and 1 Normally Closed contact

<b>Environmental protection (IP rating)</b>	EN60529 (IP54)
<b>Vandal resistance</b>	EN81-71
<b>Code compliance</b>	EN81-20, EN81-70

## Cutouts & stud positions

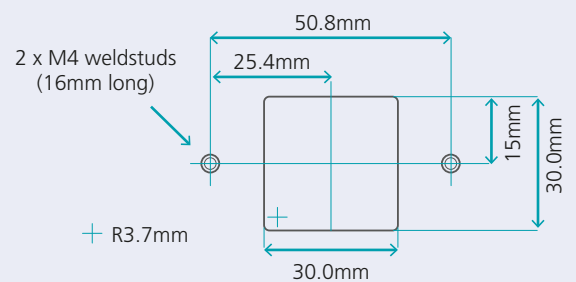

Pushbuttons with Compact 3 and Compact 3P switch bodies can be supplied loose or incorporated into stations. These have a vertical pitch of 50mm and a horizontal pitch of 60mm (Compact 3), or 80mm (Compact 3P), which means the switch body can be rotated 90 degrees.

If the pushbutton is supplied loose, spacers will be provided to accommodate the differing faceplate thickness.

Dewhurst Compact 3 & Compact 3P switch bodies are designed and tested to last

over **10 million operations.**



# Switch body | Compact 2 Micro

The switch body is the functional part of the pushbutton. The Compact 2 Micro switch body is available with one NO contact configuration. It also offers single, dual and bicolour illumination options.

## Dimensions

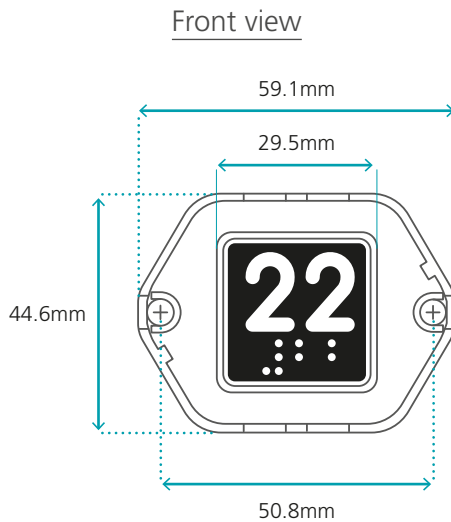

## Compact 2 Micro

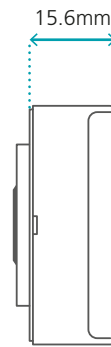

The compact 2 Micro switch body is low profile.

## Technical details

Power (continuous)	2.5 watts (maximum)
Contact arrangement	1 Normally Open contact

Environmental protection (IP rating)	EN60529 (IP54)
Vandal resistance	EN81-71
Code compliance	EN81-20, EN81-70

## Cutouts & stud positions

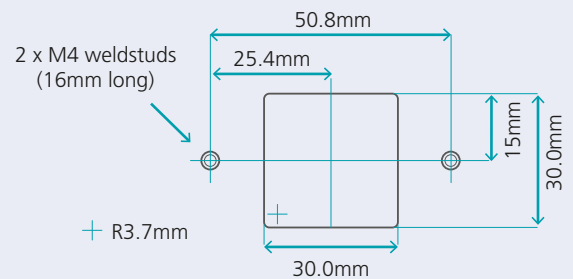

Pushbuttons with Compact 3 and Compact 3P switch bodies can be supplied loose or incorporated into stations. These have a vertical pitch of 50mm and a horizontal pitch of 60mm (Compact 3), or 80mm (Compact 3P), which means the switch body can be rotated 90 degrees.

If the pushbutton is supplied loose, spacers will be provided to accommodate the differing faceplate thickness.

Dewhurst Compact 2 Micro switch bodies are designed and tested to last



over **1 million operations.**



# Illumination

There are a wide range of interchangeable and easily replaceable LED illumination options available for Dewhurst pushbuttons. All options illuminate both the legend (character or symbol) and the halo (circle of light created between the pressel and the surround).

The US96-EN offers a choice of single, dual, bicolour and bicolour+ illumination, all of which are available with Compact 3 and Compact 3P switch bodies. The Compact 2 Micro switch body comes with single, dual or bicolour illumination.

LED colours are available in blue, white, red, amber and green.

## Single illumination

Before call acceptance	After call acceptance
	
Both the legend and the halo are non-illuminated	The legend and halo are both illuminated at full brightness of any colour

## Dual illumination

Before call acceptance	After call acceptance
	
Both the legend and the halo are illuminated at 10% of full brightness of any colour	The legend and halo are both illuminated at full brightness of the same colour

## Bicolour illumination

Before call acceptance	After call acceptance
	
Both the legend and the halo are illuminated white at 10% of full brightness	The legend and halo are both illuminated at full brightness of any colour

## Bicolour+ illumination

Before call acceptance	After call acceptance
	
Both the legend and the halo are illuminated at full brightness of any initial colour	The legend and halo are both illuminated at full brightness of a different colour

Note: the initial white illumination before call acceptance is still visible after call acceptance. This may result in the chosen colour being slightly lighter than full brightness of other illumination options.

Note: Bicolour+ illumination isn't available with the Compact 2 Micro switch body.

## Technical details

<b>LED current</b>	20mA (typically)
<b>LED voltage (±15%)</b>	12V DC, 24V DC, 110V AC

# Pressel

The pressel (the faceplate of the Dewhurst pushbutton) is available in the below standard material finishes for the US96-EN. There is an extensive range of pressel legends to choose from. All legends are 15mm high and tactile, with standard English braille dots below. Bespoke characters are available on request.

## Material finishes

Black anodised



Green anodised



Yellow anodised

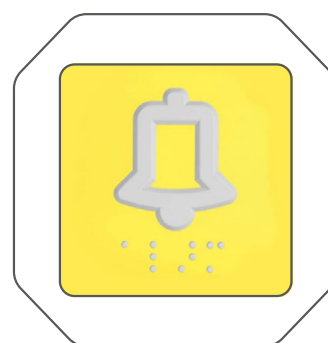

Standard US96-EN pressels are moulded with opal polycarbonate, but other colours are available on request.

# Surround

The surround is the element of the pushbutton which sits in front of the pressel and clicks into the switch body. Dewhurst pushbutton surrounds are available in a wide variety of material, depth and colour.

## Material finishes

Standard material finishes include clear plastic, chrome, brass, satin chrome, black and green.

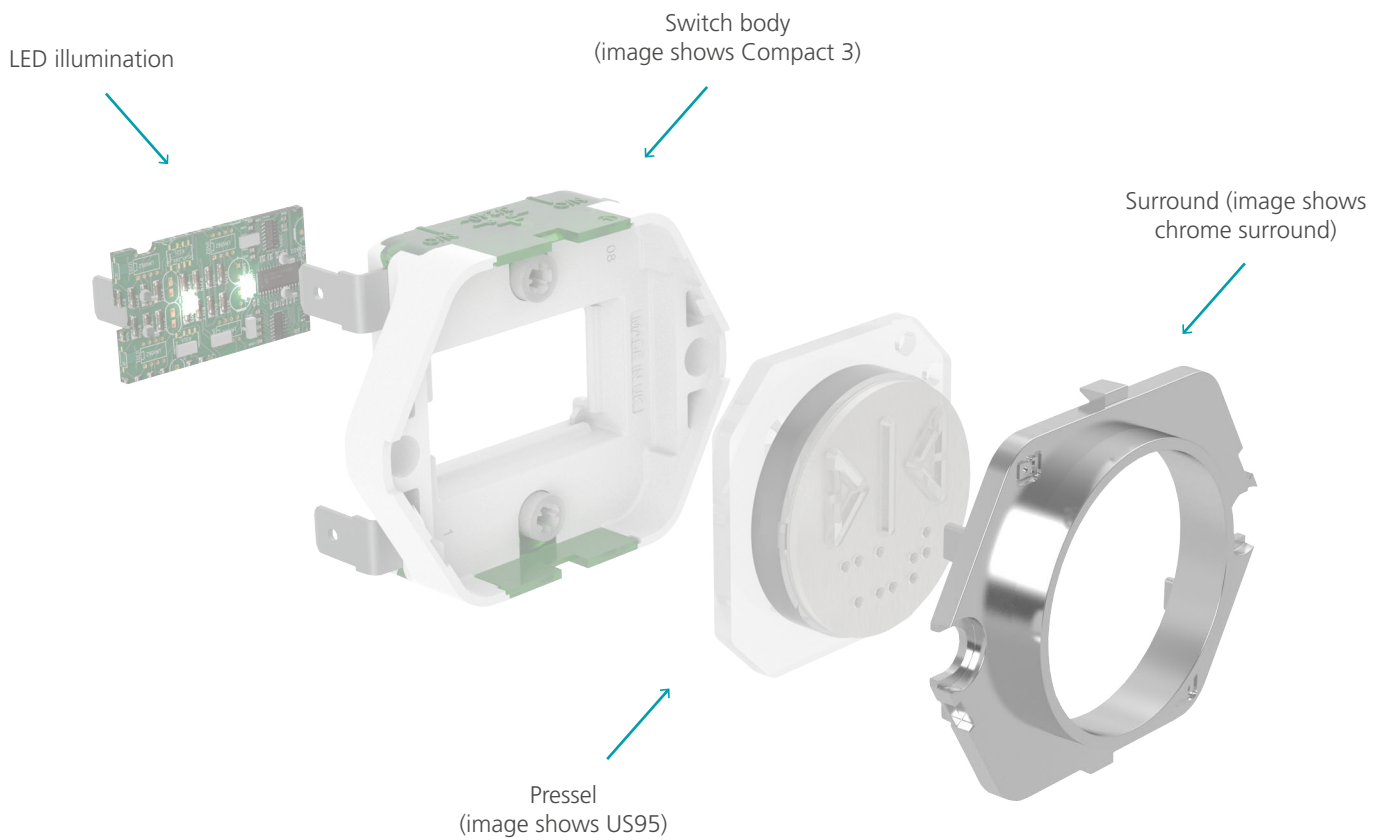

## Surround depths

All measurements are the protrusion through the faceplate.

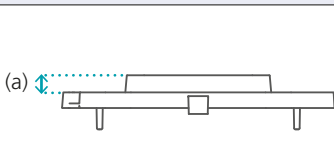
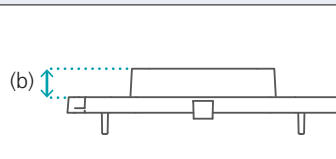
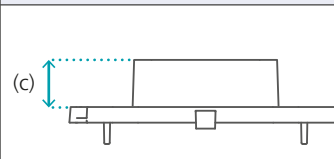
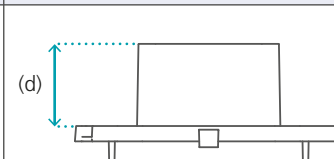
Standard	B44	Exit	Long neck
			
(a) 3mm	(b) 4.6mm	(c) 7.1mm	(d) 12mm, 14mm OR 22mm

# Cleaning your Dewhurst pushbutton

Many Dewhurst lift products are made of polycarbonate (Using GE's Lexan® or Bayer's Makrolon®). The US96-EN is highly durable and vandal resistant, but plastic parts can be damaged by aggressive cleaning agents.

## Recommended guidance



Clean with a **cotton cloth** and **warm water** before applying the cleaning product.



Use **PH-neutral** or slightly acid cleaning products only (including aromatised ones).



**Ethylic alcohol, isopropyl alcohol** or **ethylene glycol** based multipurpose cleaning products and dish soaps are suggested. Dilute the cleaning product in warm water and apply using a wet cotton cloth.



Grease, glue and paint may be removed with **ethylic alcohol** or **isopropyl alcohol**.

## DO NOT USE

- ✗ Abrasive cleaning agents
- ✗ Cleaning agents at high temperatures
- ✗ Antibacterial detergent
- ✗ Sharp tools to remove dirt (chewing gum, glue, etc.)
- ✗ Solvents based with Ketones, benzene, methanol, toluene (methylbenzene or phenyl methane)
- ✗ Alkaline and ammonia based cleaning agents or ones containing citrus

**DO NOT** leave cleaning agents on the parts for long periods of time: remove immediately after cleaning using a damp cotton cloth.